

# Installation Instructions

## VidaMount VESA Tablet Enclosure - Surface Pro 4

### Important Note



For best results, use VidaMount VESA brackets (from VidaBox) for this enclosure. It has been specifically fitted to work with this item.  
Other VESA mounting hardware can only be used after carefully checking the VESA mount screw length (Step F). Too long a screw will crush and damage the tablet!

### Component Checklist

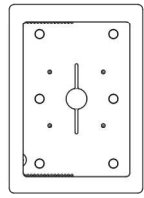

Surface Pro 4 Resin Enclosure  
(Already assembled)

TOOLS YOU'LL NEED (not included)



Phillips head  
Screwdriver



Knife / Box Cutter  
(OPTIONAL)

### A Disassembling the Enclosure

Remove the flat-head screws as shown. Set aside the loose hardware carefully.

We will need this hardware again later.

We now have (2) pieces:

- A. The front face plate
- B. The back plate

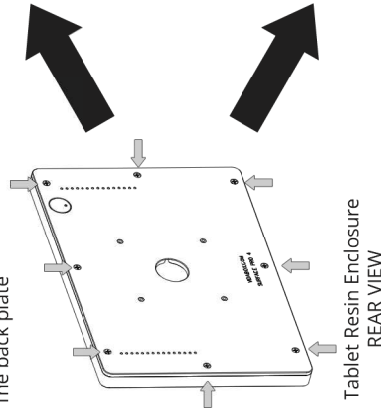

**IMPORTANT:** Diagrams are generalized. Your exact enclosure may appear slightly different!

### B Optional : Remove Power Button Knockout (If needed)

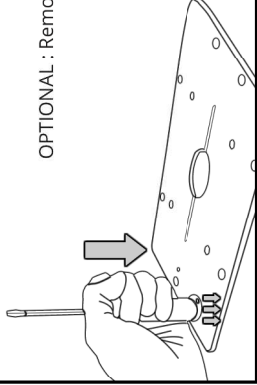

OPTIONAL : Remove only if access to the power button is always required.

Using the blunt end of the screwdriver, press down on the circular knockout, as shown.

This will pop out the power button access panel.

### C Optional : Cut Wiring Grooves (If needed)

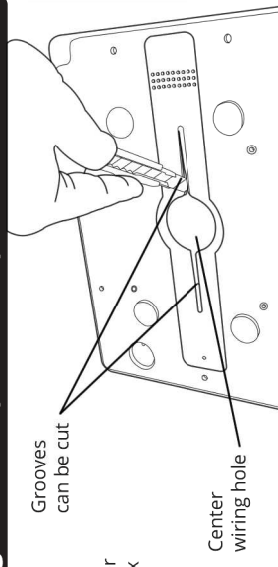

Grooves can be cut

OPTIONAL : Remove only if necessary.

If using a VESA mount where the center wiring hole is blocked, use a knife / box cutter, and cut out the grooves.

This will allow the tablet's wires to be routed properly.

### D Install Tablet into Front Face Plate

Orient the tablet properly and install it into the front face plate as shown.

Be sure that the power button, headphone out, and USB cable ports line up properly.

Micro USB Cable

Connect the USB cable now. It will need to be routed through the center hole in the next steps.

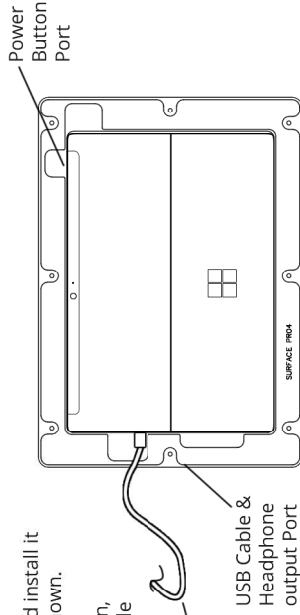

### E Install VESA Mount onto Back Plate

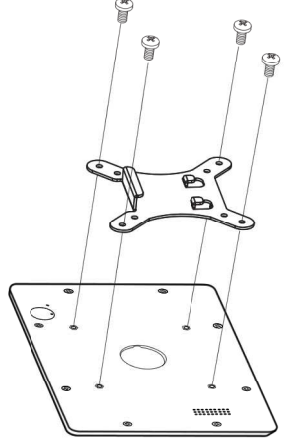

Install the VESA mount we'll be using onto the back plate.

## Important Note

For best results, use VidaMount VESA brackets (from VidaBox) for this enclosure. It has been specifically fitted to work with this item.  
Other VESA mounting hardware can only be used after carefully checking the VESA mount screw length (Step F). Too long a screw will crush and damage the tablet!



## F Check VESA screw length (On non-VidaBox VESA Mounts)

With the VESA screws installed, look on the inside of the back plate.

Check to make sure that the screw lengths DO NOT PROTRUDE beyond 1/16" from the back plate surface. See diagrams below.

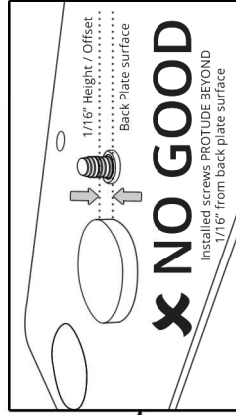

New, shorter screws will be needed. Using these screws WILL DAMAGE the tablet when enclosure is fully assembled!

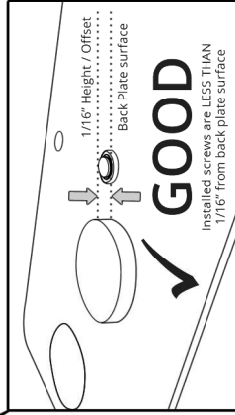

Proceed to Step G ONLY after the screw length is confirmed "Good."

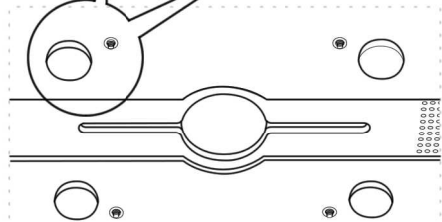

## G Reassemble the Enclosure

Reinstall the screws removed in Step A.

Be sure the USB cable can be routed out of the enclosure. If not, go back to Step C and cut the grooves needed.

Micro-USB/  
Power Cable

The tablet is now securely installed in the enclosure!

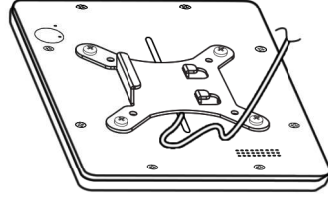
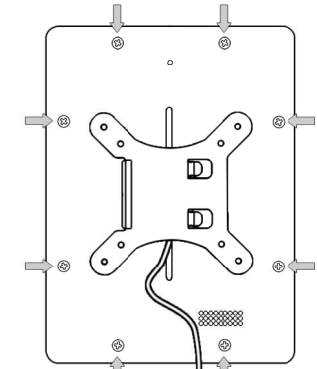

# INSTALLATION GUIDE

## VidaMount VESA Tablet Enclosure

### For Windows Surface Pro 4 Tablets

## VB\_VESA\_SPRO4

Designed to securely enclose Windows Surface Pro 4 tablets  
Fits Windows Surface Pro 4 tablets ONLY  
Compatible with VESA 100x100 mounts

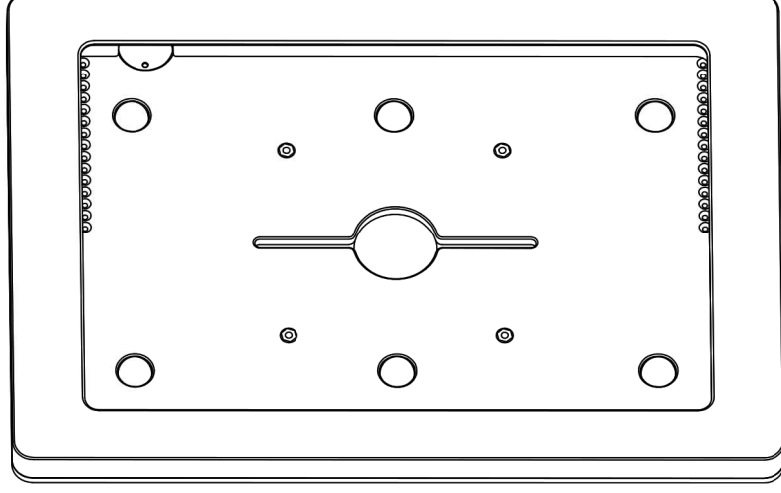

(Tablets are shown for illustrative purposes & not included)