

C For Dry Wall / Concrete Wall Mounting ONLY

1) Drill holes & insert anchors.

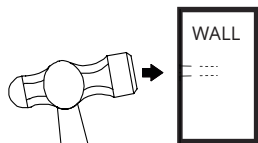

2) Place wall plate over anchor.

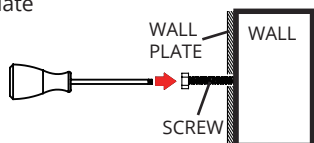

3) Secure with Screw Set [E]

4) Tighten all fasteners.

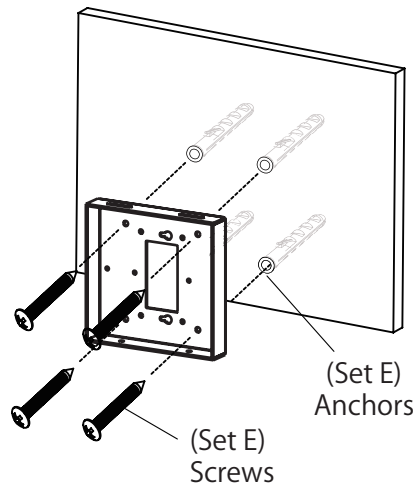
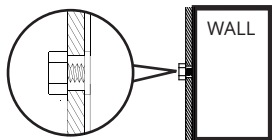

INSTALLATION GUIDE

Fixed Tilt VESA Surface Mount

VB_VESA_MNT_FTS

Ideal for VidaMount VESA Tablet Enclosures
VESA 100x100 & 75x75 compatible

D Mount VESA Device

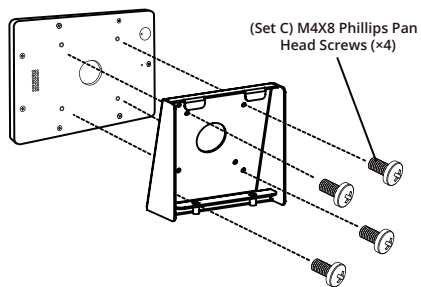

E Assemble Bracket Together

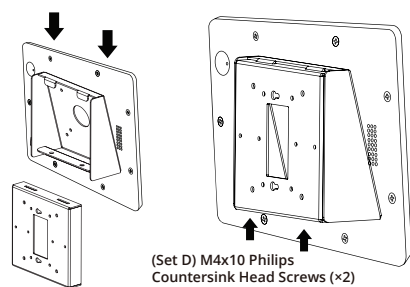

F OPTIONAL / Desktop Setups : Add Kensington Lock

Install a Kensington lock to secure desktop mounts

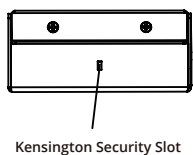

+



=

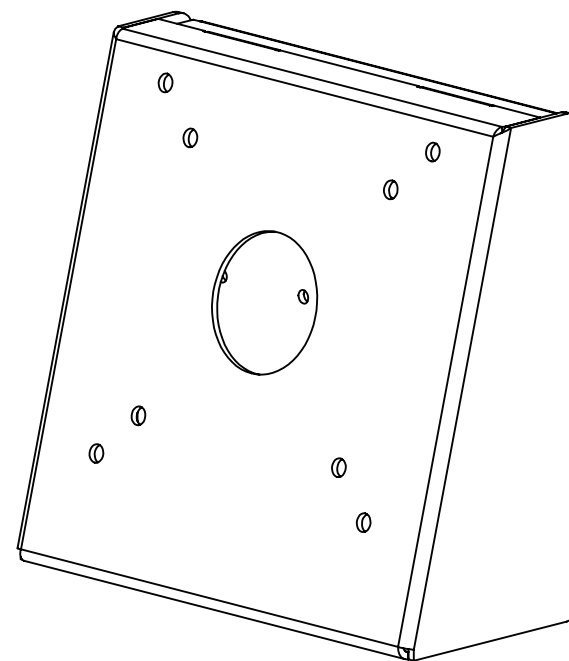
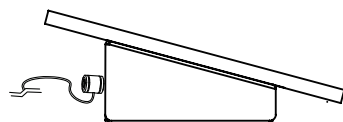

Installation Instructions

Fixed Tilt Surface Mount : VESA Compatible

Important Note:

- If charging is desired, please prepare the extension cable and/or charging solution for the VESA tablet first. Installing the charging solution / extension cable will be easier to do now than it will be to do later.
- VESA : 75 x 75mm (3" x 3") and 100 x 100mm (4" x 4") compatible.

Component Checklist:

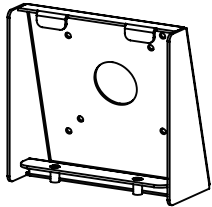

VESA plate

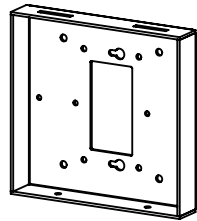

Wall plate



(Set A) #6-32 x 1" Phillips Pan Head Screws (x4)
[For US Gang Boxes]



(Set B) M3.5X25 Phillips Pan Head Screws (x2)
[For EU Gang Boxes]



(Set B) M4 Washers (x2)
[For EU Gang Boxes]



(Set C) M4X8 Phillips Pan Head Screws (x4)
[For VESA bracket to VESA device mounting]



(Set D) M4x10 Phillips Countersink Head Screws (x2)
[To secure Tilting Bracket together]



(Set E) M5x35 Phillips Pan Head Wood Screws (x4)
[For Direct / Dry Wall Mounting]



(Set E) M7x35 Anchor (x4)
[For Direct / Dry Wall Mounting]

(A) Question: Desktop or Wall Mount?

Desktop - If we are using this on a desk / table top, with no need to anchor the mount, start with **Step D** on page 4.

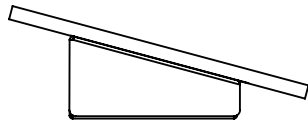

Wall Mount - If we are mounting onto a gangbox or wall, choose one of the hole sets as shown on right...

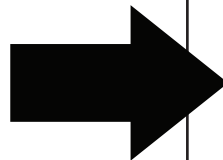

(B) For Wall Mounting : Select hole pattern to use

Option 1. For US single gang box or Decora Outlet overlay.
Secure to gangbox with Screw Set [A]. Then, Proceed to Step D (Page 4)

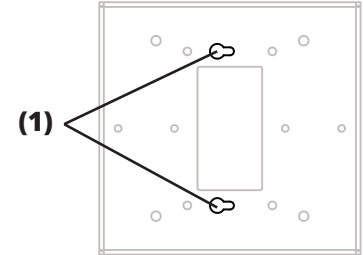

Option 2. For US double gang box, with no outlet.
Secure to gangbox with Screw Set [A]. Then, Proceed to Step D (Page 4)

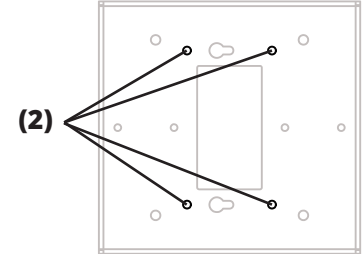

Option 3. For EU single gang box.
Secure to gangbox with Screw Set [B]. Then, Proceed to Step D (Page 4)

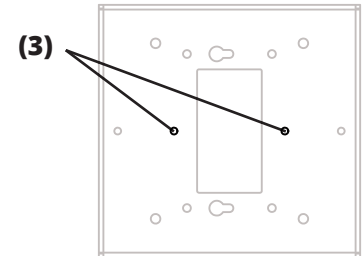

Option 4. For EU double gang or UK / British quad face box.
Secure to gangbox with Screw Set [B]. Then, Proceed to Step D (Page 4)

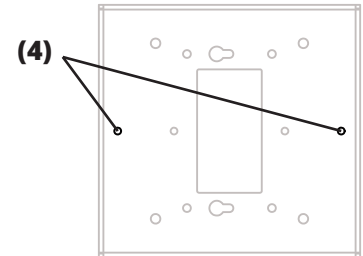

Option 5.
For Direct / Dry Wall Mounting.
Secure to wall using Anchors & Screw Set [E]. Then, Proceed to Step C (Page 4)

