

Important Note



For best results, use VidaMount VESA brackets (from VidaBox) for this enclosure. It has been specifically fitted to work with this item.

Other VESA mounting hardware can only be used after carefully checking the VESA mount screw length (Step F). Too long a screw will crush and damage the iPad!

F Check VESA screw length (On non-VidaBox VESA Mounts)

With the VESA screws installed, look on the inside of the back plate.

Check to make sure that the screw lengths DO NOT PROTRUDE beyond 1/16" from the back plate surface. See diagrams below.

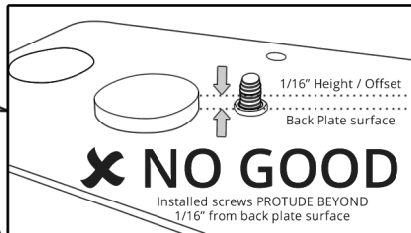
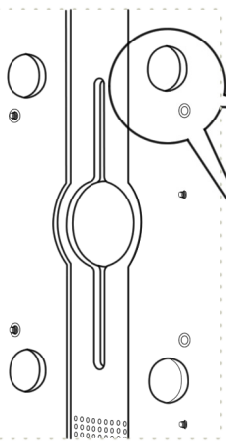

New, shorter screws will be needed. Using these screws WILL DAMAGE the iPad when enclosure is fully assembled!

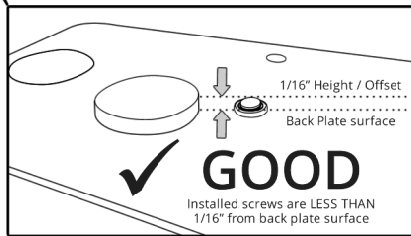

Proceed to Step G ONLY after the screw length is confirmed "Good."

G Reassemble the Enclosure

Reinstall the (7) screws removed in Step A.

Be sure the iPad cable can be routed out of the enclosure. If not, go back to Step C and cut the grooves needed.

iPad USB-C Cable

The iPad is now securely installed in the enclosure!

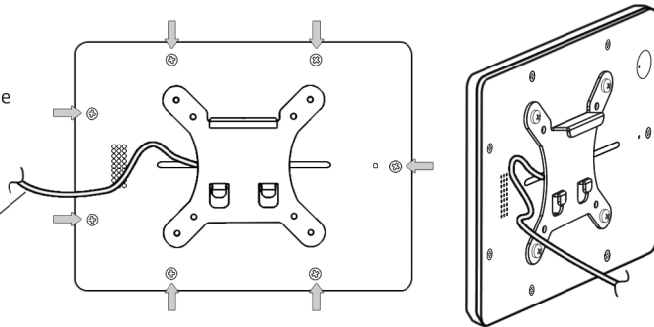

INSTALLATION GUIDE

VidaMount VESA Tablet Enclosure For iPad Air 4 & Pro 11" 1/2 Tablets

VB_VESA_IPRO2G110

Designed to securely enclose iPad Air 4 & Pro 11" 1/2 tablets

Fits iPad Air 4th Gen & Pro 11" 1st/2nd Gen tablets ONLY

Compatible with VESA 100x100 mounts

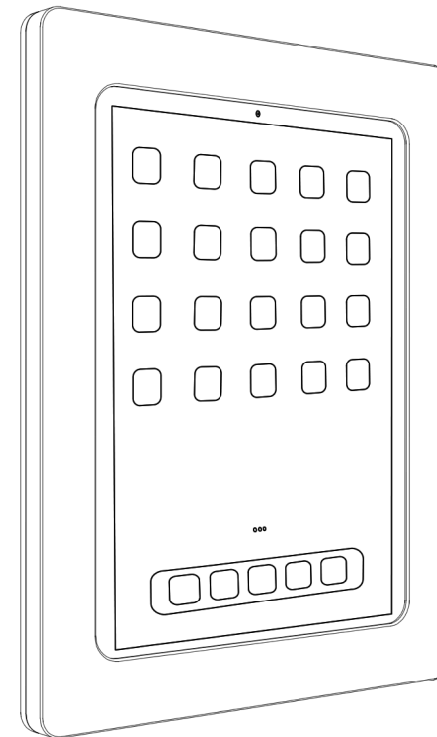

(iPad is shown for illustrative purposes & not included)



125 Newtown Rd, Ste 100
Plainview, NY 11803 USA

Toll-free US: (844) 4-KIOSKS
Worldwide: +1 516-499-5050
Australia: +61 1300 44 VIDA
EU/UK: +44 333 444 VIDA

Installation Instructions

VidaMount VESA Enclosure - iPad Air 4 & Pro 11" 1/2

Important Note



For best results, use VidaMount VESA brackets (from VidaBox) for this enclosure. It has been specifically fitted to work with this item.

Other VESA mounting hardware can only be used after carefully checking the VESA mount screw length (Step F). Too long a screw will crush and damage the iPad!

Component Checklist

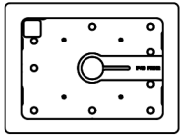

iPad Resin Enclosure
(Already assembled)

TOOLS YOU'LL NEED (not included)



Phillips head
Screwdriver

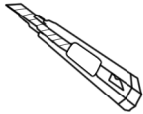

Knife / Box Cutter
(OPTIONAL)

A Disassembling the Enclosure

Remove the flat-head screws as shown. Set aside the loose hardware carefully.

We will need this hardware again later.

We now have (2) pieces:
A. The front face plate
B. The back plate

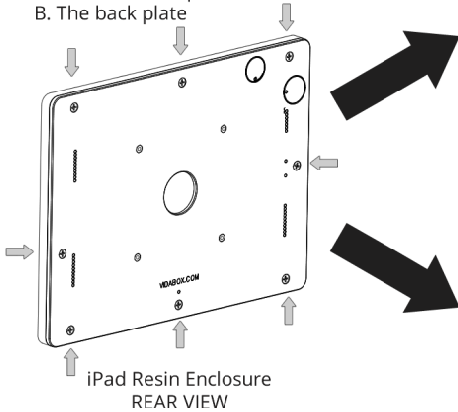

A. FRONT FACE PLATE

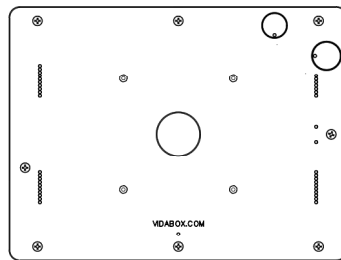
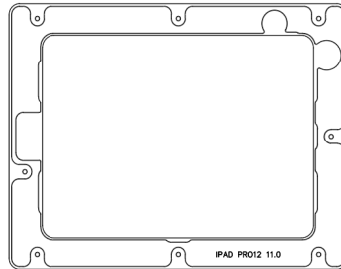

B. BACK PLATE

IMPORTANT: Diagrams are generalized for iPads - your exact enclosure may appear slightly different!

B Optional : Remove Power Button Knockout (If needed)

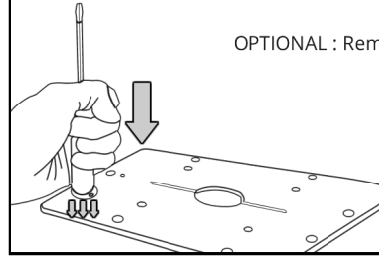

OPTIONAL : Remove only if access to the power button is always required.

Using the blunt end of the screwdriver, press down on the circular knockout, as shown.

This will pop out the power button access panel.

C Optional : Cut Wiring Grooves (If needed)

OPTIONAL : Remove only if necessary.

If using a VESA mount where the center wiring hole is blocked, use a knife / box cutter, and cut out the grooves.

This will allow the tablet's wires to be routed properly.

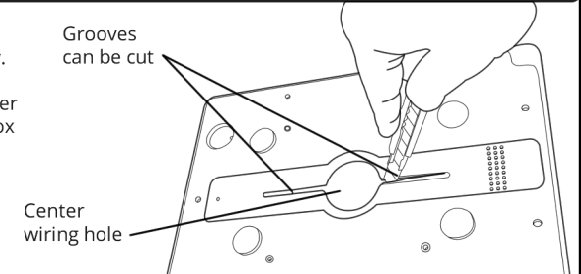

D Install iPad into Front Face Plate

Orient the iPad properly and install it into the front face plate as shown.

Be sure that the power button, volume buttons, and USB-C cable ports line up properly.

Connect the iPad cable now. It will need to be routed through the center hole in the next steps.

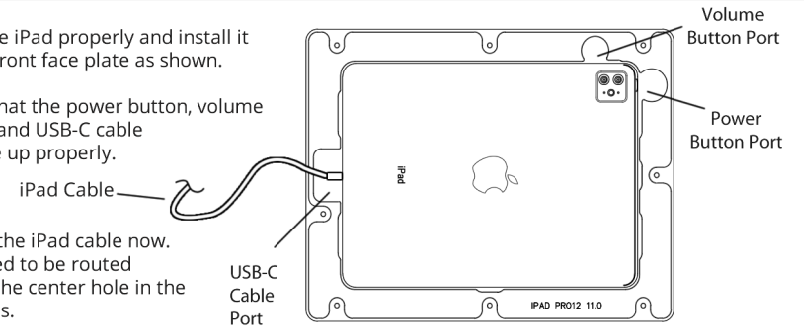

E Install VESA Mount onto Back Plate

Install the VESA mount we'll be using onto the back plate.

