

Important Note



For best results, use VidaMount VESA brackets (from VidaBox) for this enclosure. It has been specifically fitted to work with this item.

Other VESA mounting hardware can only be used after carefully checking the VESA mount screw length (Step F). Too long a screw will crush and damage the iPad!

F Check VESA screw length (On non-VidaBox VESA Mounts)

With the VESA screws installed, look on the inside of the back plate.

Check to make sure that the screw lengths DO NOT PROTRUDE beyond 1/16" from the back plate surface. See diagrams below.

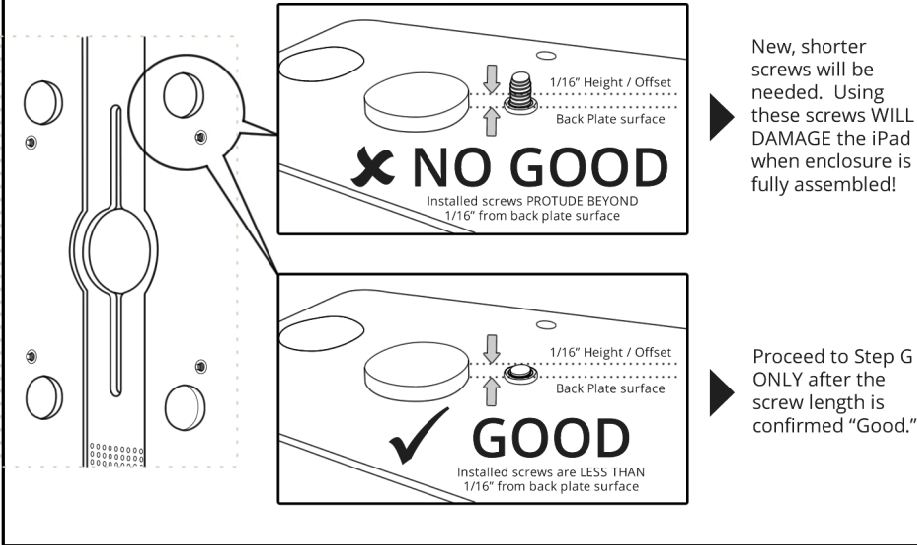

G Reassemble the Enclosure

Reinstall the (7) screws removed in Step A.

Be sure the iPad cable can be routed out of the enclosure. If not, go back to Step C and cut the grooves needed.

iPad USB/
Lighting Cable

The iPad is now securely installed in the enclosure!

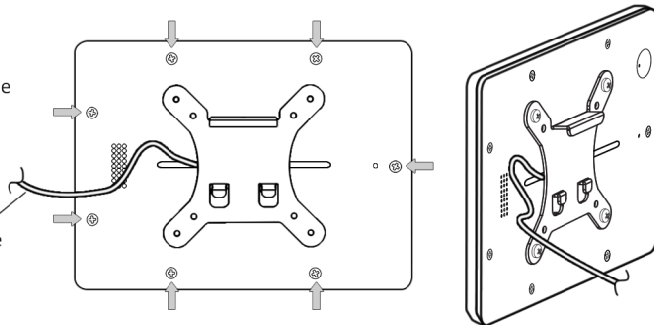

INSTALLATION GUIDE

VidaMount VESA Tablet Enclosure For iPad Mini 4

VB_VESA_MINI4

Designed to securely enclose iPad mini tablets

Fits iPad mini 4

Compatible with VESA 100x100 mounts

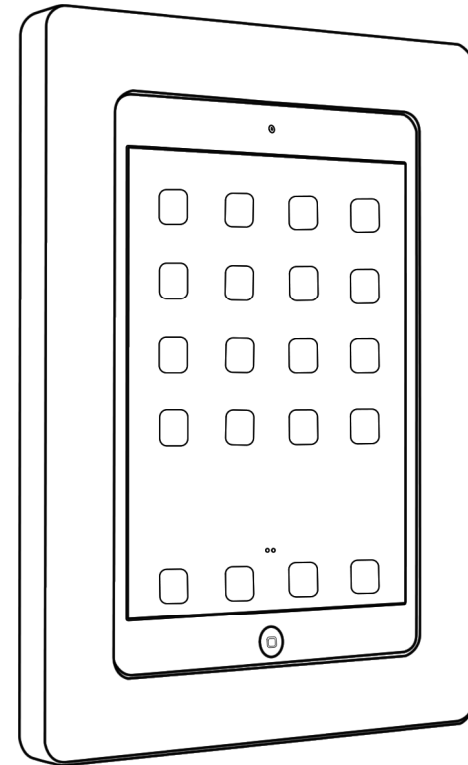

(iPad is shown for illustrative purposes & not included)

Installation Instructions

VidaMount VESA Tablet Enclosure - iPad Mini 4

Important Note



For best results, use VidaMount VESA brackets (from VidaBox) for this enclosure. It has been specifically fitted to work with this item.

Other VESA mounting hardware can only be used after carefully checking the VESA mount screw length (Step F). Too long a screw will crush and damage the iPad!

Component Checklist

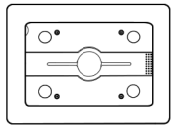

iPad Resin Enclosure
(Already assembled)

TOOLS YOU'LL NEED (not included)



Phillips head
Screwdriver

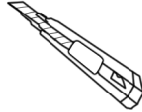

Knife / Box Cutter
(OPTIONAL)

A Disassembling the Enclosure

Remove the flat-head screws as shown. Set aside the loose hardware carefully.

We will need this hardware again later.

We now have (2) pieces:
A. The front face plate
B. The back plate

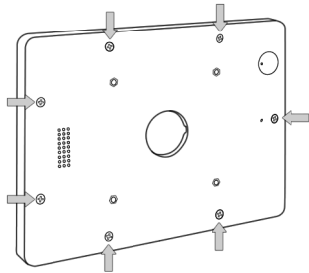

iPad Resin Enclosure
REAR VIEW

A. FRONT FACE PLATE

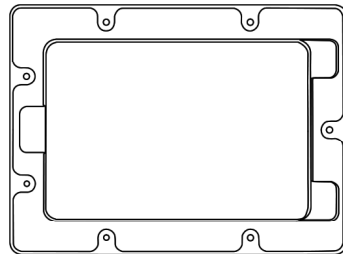

B. BACK PLATE

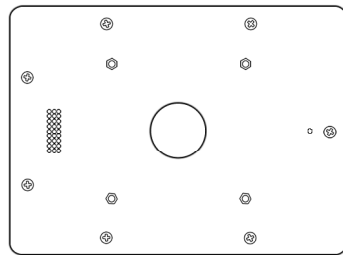

B Optional : Remove Power Button Knockout (If needed)

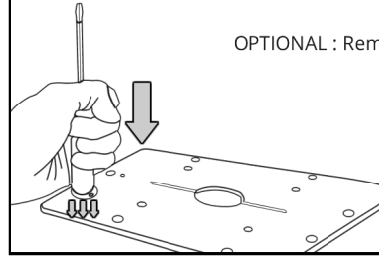

OPTIONAL : Remove only if access to the power button is always required.

Using the blunt end of the screwdriver, press down on the circular knockout, as shown.

This will pop out the power button access panel.

C Optional : Cut Wiring Grooves (If needed)

OPTIONAL : Remove only if necessary.

If using a VESA mount where the center wiring hole is blocked, use a knife / box cutter, and cut out the grooves.

This will allow the tablet's wires to be routed properly.

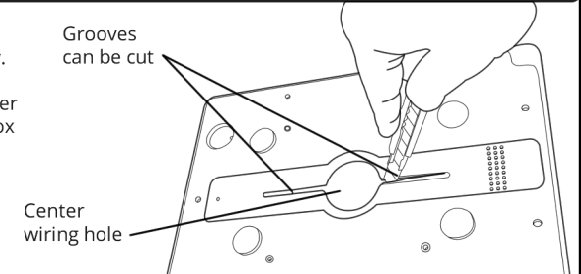

Grooves
can be cut

Center
wiring hole

D Install iPad into Front Face Plate

Orient the iPad properly and install it into the front face plate as shown.

Be sure that the power button, headphone out, and USB cable ports line up properly.

Connect the iPad cable now. It will need to be routed through the center hole in the next steps.

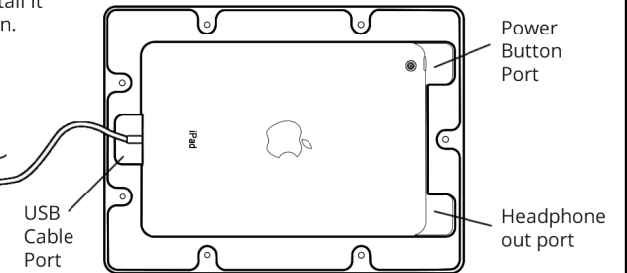

E Install VESA Mount onto Back Plate

Install the VESA mount we'll be using onto the back plate.

