

# INSTALLATION GUIDE

## Keyboard Tray for Fixed VidaMounts

### VB\_VESA\_ACC\_KT

Ideal for Fixed VESA Floor Stands & Desk/Wall Surface VESA Mounts  
Fits mini & compact keyboards with 5.25" maximum width

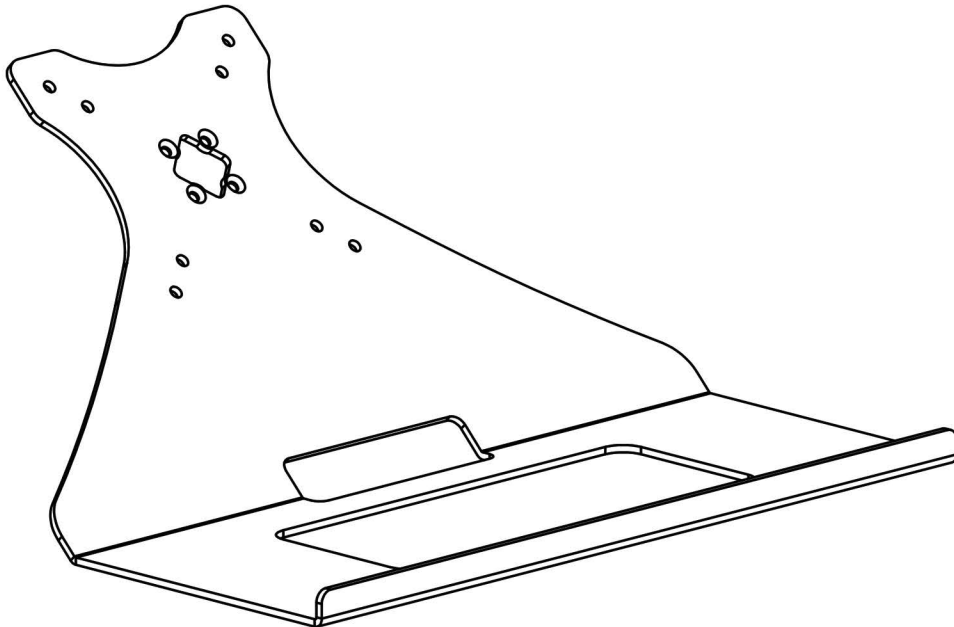

**Compatible with & Replaces  
VESA plates of:**

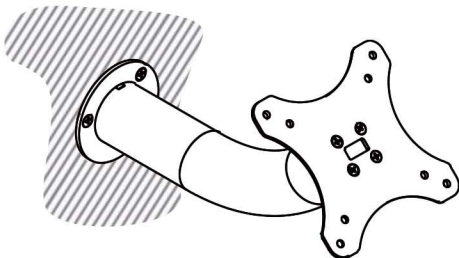

Fixed Surface VESA Mounts (FXS)

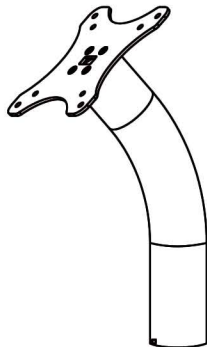

Fixed VESA  
Floor Stands  
(FFS)

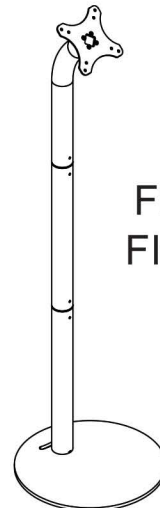

# Installation Instructions

## Keyboard Tray for Fixed VidaMounts

### Important Note:

- If charging is desired, please prepare the extension cable and/or charging solution for the VESA enclosure first. Installing the charging solution / extension cable will be easier to do now than to do it later.
- Compatible only with VidaBox Fixed VidaMounts. Not recommended / compatible with other products.
- VESA: 75" x 75" (3" x 3") and 100 x 100 (4" x 4")

### Component Checklist:

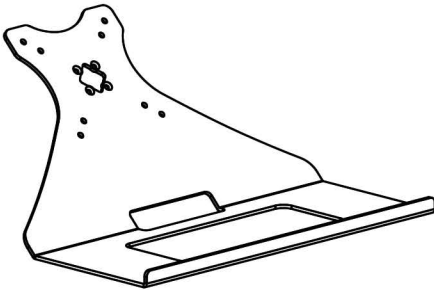

Keyboard Tray

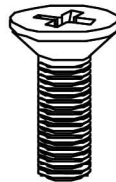

(4) M4 x 8mm Philips  
Countersink Head Screws

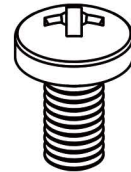

(4) M4 x 8mm Philips  
Pan Head Screws

### A Follow instructions to assemble your mount, but STOP at:



**For Fixed Surface Mount (FXS)**  
**PAUSE on STEP 4**  
(Do not Install VESA Enclosure)



**For Fixed Floor Stand (FFS)**  
**PAUSE on STEP 3**  
(Do not Install VESA Enclosure)

4 Install VESA-Ready Enclosure

**PAUSE**  
**THIS**  
**STEP**

M4x8 Philips  
Head Screws

3 Mount the VESA Compatible Device

**PAUSE**  
**THIS**  
**STEP**

## B Replace VESA Mount Plate with Keyboard Tray

Install the Keyboard Tray now, using the (4) M4X12 Phillips Countersink Head Screws

For: Fixed Surface Mount (Desk)

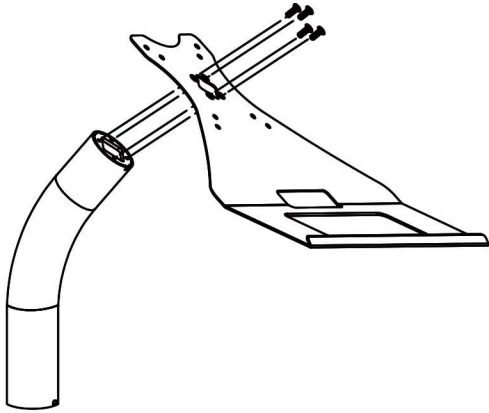

For: Fixed Floor Stand

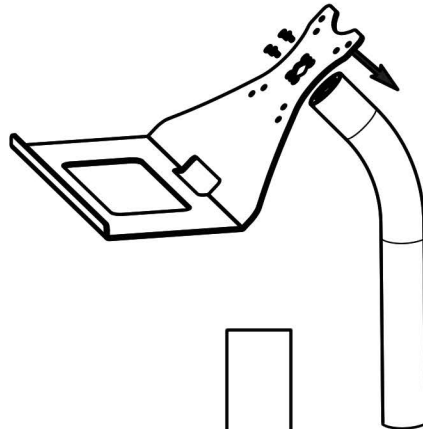

For: Fixed Surface Mount (Desk)

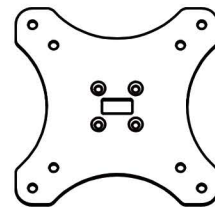
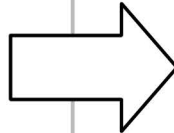
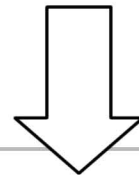
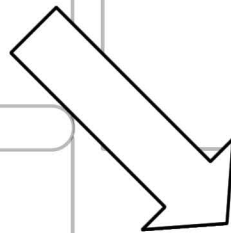
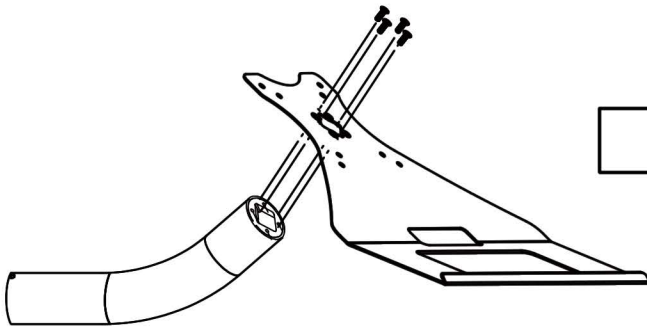

Set aside this extra  
VESA Mounting Plate.  
(IMPORTANT: Do not throw out.)

## C Optional: Cut Wiring Groove, to Connect Keyboard Wire to Device

If a wired keyboard is used, place your keyboard onto the tray and run the wire into your VESA enclosure / device now.

[Hint: You may need to "Cut the Wiring Grooves shown in Step C of the VESA enclosure's instructions, for the cable to enter in.]

Grooves can be cut

Center wiring hole

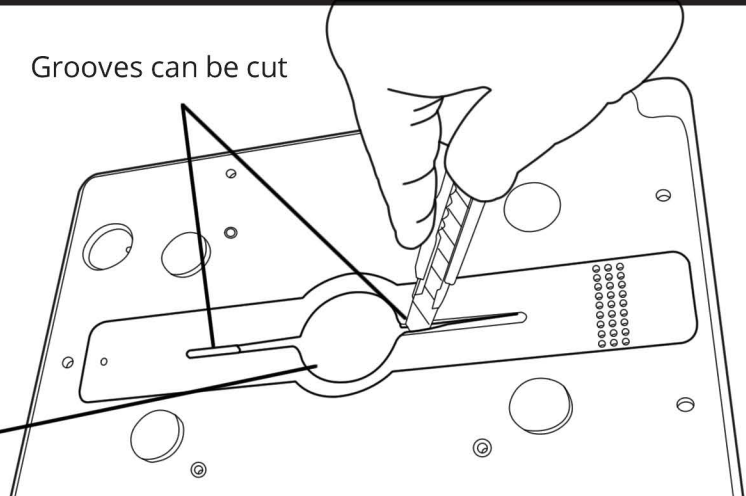

## D Install the VESA Enclosure / Device

Resume with the "Paused Step" from Step A - and install your VESA Enclosure onto the VESA Mount.

You can place your mini / compact keyboard onto the tray.

Your setup is now complete!

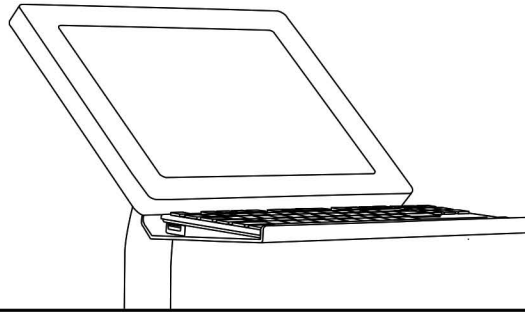

## Dimensions / Diagrams

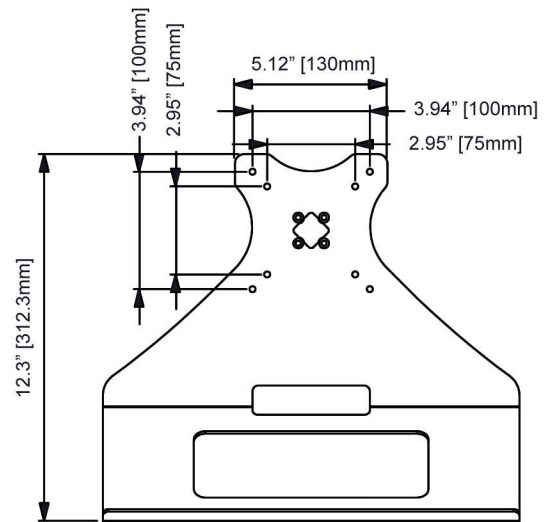
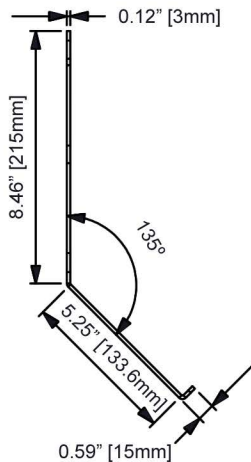
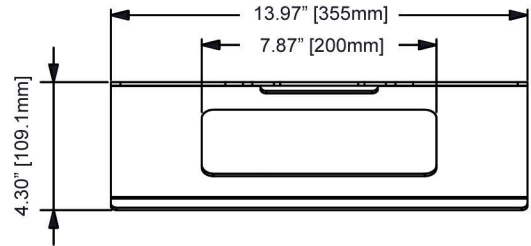
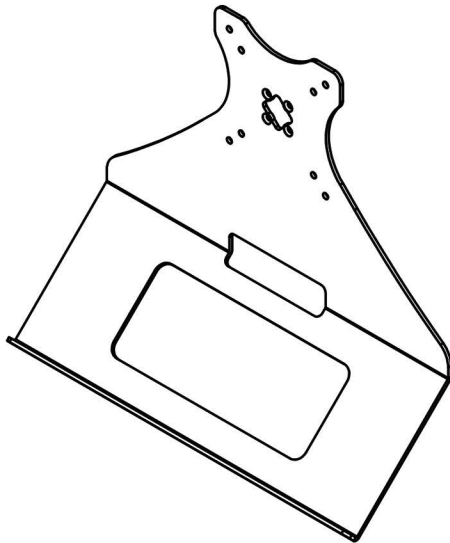

Top View

### IMPORTANT:

Keyboard Tray only fits  
Compact / Mini Keyboards with  
maximum width of 5.25" [133.6mm]

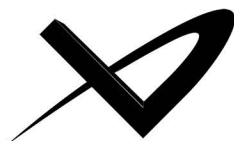

# VIDA BOX

VidaBox LLC

125 Newtown Rd, Ste 100, Plainview, NY 11803

Toll-free US: (844) 4-KIOSKS · Worldwide: +1 516-499-5050

Australia: +61 1300 44 VIDA · EU/UK: +44 333 444 VIDA